











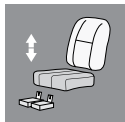





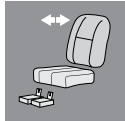

The user manual for your control panel contains information on how to operate your wheelchair. The model 3 power wheelchairs have updated graphics from those seen in the user manual. Please refer to the table below for a visual translation of example icons.

You can find the user manual for your control panel here:



https://documentation.permobil.com/manuals/control_panels/

Basic icons	Old	New	Example icons	Old	New
Hare			Seat lift		
Turtle			Seat tilt		
Focus			Backrest		
Temperature			Leg support		
Cruise latch					

The following are some of the new functions on your control panel.



1. Battery level

- The levels of the battery are displayed as follows:
 - green 45–100%
 - yellow 25–44%
 - red 0–24%
- The battery bar flashes when it changes from green to yellow and between yellow levels. It flashes repeatedly at red level.
- The battery level is also shown as a percentage number to the right of the battery bar. It changes in steps of five percent.

2. Arrows

- The arrows indicate which directions you can adjust a function.
- If a direction is not possible, the arrow is grey.
- The arrow flashes between white and grey when a function has reached its end position.

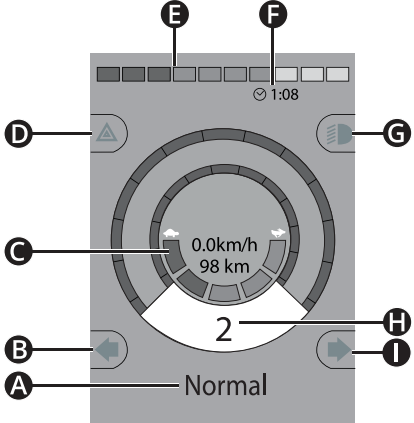
Refer to the table below for a comparison of the old and new screen of your control panel.



Screen overview	Old	New
<p> A Profile name B Left indicator and leg support tilt C Maximum speed indicator D Hazard lights and seat lift E Battery indicator F Clock G Lights (and backrest tilt) H Profile number I Right indicator (and seat tilt) </p> <p> Ⓓ Current speed or limitations in seat mode, see below. </p>		

3. Circle Ⓓ

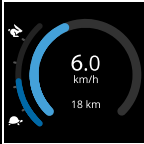
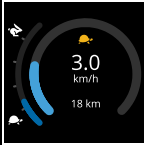
- When in drive mode, any restrictions on the maximum speed are displayed as a combination of the circle and orange tortoise.

<p>The maximum speed is set to 6 km/h and no restrictions are applied.</p>	
<p>The maximum speed is restricted to 3 km/h, which is indicated by two things:</p> <ul style="list-style-type: none"> the reduced bar on the left for the maximum speed setting, and the orange tortoise displayed in the middle of the screen. 	

- When seat mode is active, the colour of the circle indicates different things:

<p>Green indicates that the maximum speed is not limited by the active seat function displayed.</p>	
<p>Yellow indicates that the maximum speed is limited by the active seat function displayed.</p>	
<p>Red indicates that drive is inhibited by the active seat function displayed.</p>	